

hcc[!] domotica-iot

Domotica met Internet-of-Things.. Of zoiets

Gjalt Zwaagstra
donderdag 12 november 2020





Domotica betekenis

Het is best een apart woord, domotica.

Dat komt omdat het een samentrekking is en daarnaast ook een relatief nieuw woord.

Het staat zelfs nog niet in de Van Dale.

Want wat is nu de betekenis van domotica?

Het eerste deel (domo) komt van het Latijnse woord domus, wat huis of woning betekent.

Het tweede deel (tica) is een toevoeging die ook bij veel andere woorden wordt gebruikt en vaak duidt op 'toegepaste wetenschap' of 'technologie'.

Denk aan informatica of robotica. Maar we hebben het nu dus over domotica, ofwel woningtechnologie!

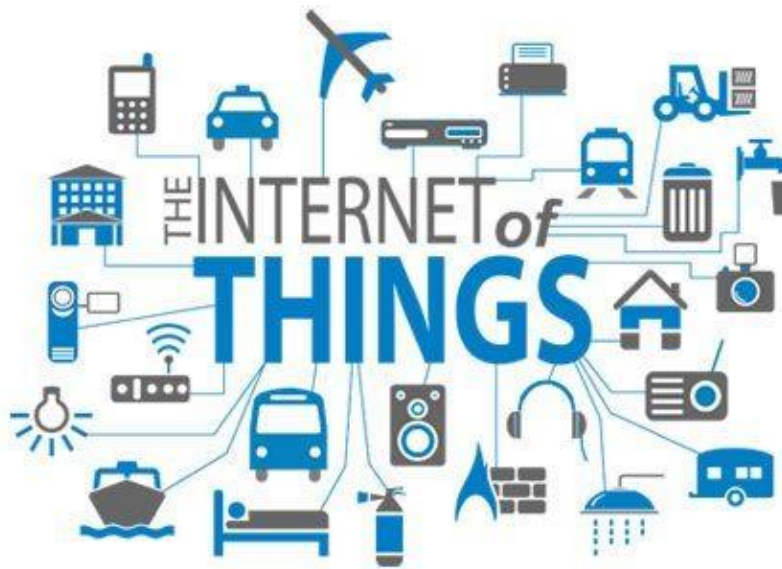

“Geavanceerde technologie is niet te onderscheiden van magie.”
Arthur C. Clarke

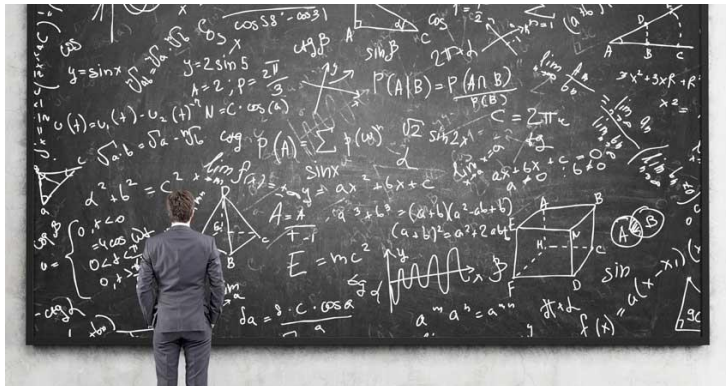
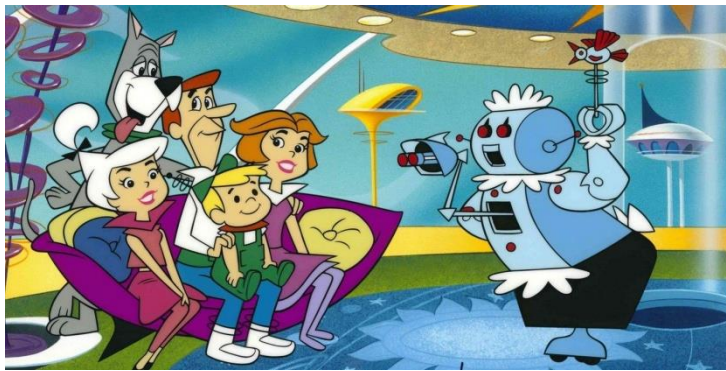

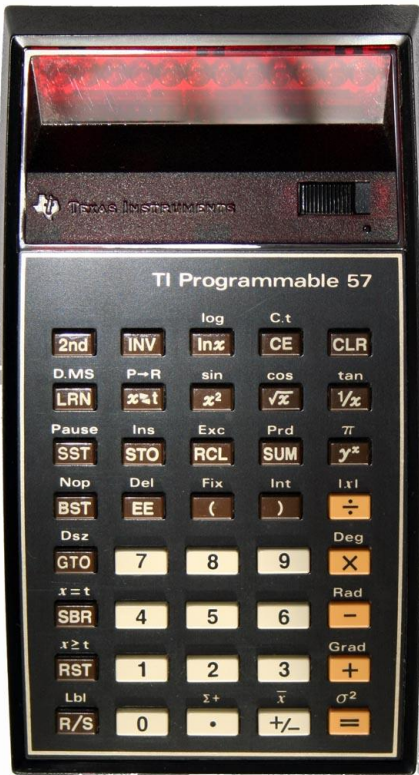

Mijn begin...

1977
Texas Instruments TI57



APPLE II 1984

Order Direct! Commodore VIC-20...The Friendly Computer.

"The first honest-to-goodness full color computer you can buy for only \$299.95" - William Shatner

Complete Line of Hardware and Software Available to Expand your VIC-20

VIC-20 - Commodore's revolutionary personal computer features color, sound, graphics, programmable function keys, built-in BASIC, expandable memory, the priced peripherals and most Connects to any TV or monitor. Includes 4K Modulator, Switchbox, cables and self-teaching instruction book. \$299.95 (See equip below)

Commodore Datasette - Provides handy economical storage of user-written or pre-recorded programs. \$75.00

VIC-8K Memory Expander Cartridge / \$99.95

VIC-20 Super Expander - 3K 16M memory expansion, high resolution graphics plotting, color, and sound commands. / \$99.95

Programmer Aid Cartridge - More than 20 new BASIC commands help new and experienced programmers. / \$59.95

RECREATIONAL GAME CARTRIDGES:
VIC AVENGERS • SUPERLOT • VIC SUPER ALIEN • SUPER LANDER / \$29.95 each

COMPUTER PROGRAM TAPES:
Requires Commodore Datasette
Reception Program Pack A - Car Chase, VIC-21, Blue Manias from Outer Space, Bionetics/Compatibility, Spasmodic, Bombroader Solver. / \$69.95

Home Calculation Program Pack A - Personal Finance / Home Budget, Personal Finance II / Home Budget, VIC Typewriter - Word processor for home use, Expense Calendar - Income, expenses, appointments, Loan A, Mortgage Calculator - Decision-making aid; Home Inventory, Home Inventory list. / \$39.95

Programmable Character Set/Graphic Editor - Lets the VIC user create up to 64 programmable characters and use them in BASIC programs. / \$14.95

Introduction to BASIC Programming - A gentle but thorough introduction to BASIC programming. Excellent first book for any new computerist. / \$24.95

VIC-20 Programmer's Reference Guide - Master VIC-20 reference manual includes information on VIC BASIC, programming and much more. / \$16.95

To order accessories simply list on separate sheet and ship to request.

Model	Commodore VIC-20	Apple II	IBM PC	TRS-80
Price	\$299.95	\$599.00	\$1,199.00	\$299.00
RAM	5K	6K	16K	8K
Color	Yes	No	No	No
Sound	Yes	No	No	No
Graphics	Yes	No	No	No
Keyboard	Yes	Yes	Yes	Yes
Printer	Yes	Yes	Yes	Yes
Modem	Yes	Yes	Yes	Yes
Expansion	Yes	Yes	Yes	Yes
Software	Yes	Yes	Yes	Yes
Reliability	Yes	Yes	Yes	Yes
Portability	Yes	No	No	No
Expandability	Yes	Yes	Yes	Yes
Upgrade	Yes	Yes	Yes	Yes
Support	Yes	Yes	Yes	Yes
Warranty	Yes	Yes	Yes	Yes
Disruptive	Yes	No	No	No

Everybody loves video games and the Commodore VIC-20 has some of the best. But the VIC-20 can also help children with their homework. Mom can use it for home budgeting. Dad can even take the lightweight, portable VIC-20 to the office for financial and business application.

The Friendly Computer at a Friendly Price: At \$299.95 the Commodore VIC-20 is the friendliest way we know to learn computing. It has a full computer keyboard even a small child can operate. It even tells you when you've made a mistake and how to correct it. (That's very friendly!)

The VIC-20 can take your children from preschool through post-graduate studies.

Why get just another game that could end up in the closet? Get an honest-to-goodness computer for just \$299.95.

Free with every VIC-20 computer this 164 page guide tells you everything you need to know about your VIC-20 and how to operate it. Written for the beginner, you'll be programming on your VIC-20 in minutes!

Order now. We'll ship your new VIC-20 computer directly to you. 15 day free trial.

Contemporary Marketing, Inc.
790 Maple Lane, Bensenville, IL 60106
Faster Service for Credit Card Customers
Call Toll Free 800-648-5600 (In Nevada call 800-992-9710)
24 hours a day

VIC-20 THE FRIENDLY COMPUTER
Commodore

Yes, I want to start using the new VIC-20 personal computer right away.

Please send me:
Commodore VIC-20 computer at \$299.95 each. (Item No. 2800). Add \$4.95 per computer for shipping and insurance.
Monthly residents include 11% sales tax.
 Check/M.C. Enclosed. Charge my credit card.
 MasterCard Visa American Express Discover Club

Name _____
Address _____
City _____ State _____ Zip _____
Signature _____

OWMP 501 Contemporary Marketing, Inc. 790 Maple Lane, Bensenville, IL 60106 (CA) 1982 263





Toen: Mensen die over computers praten (bij de hcc)

Nu: Computers die over mensen praten (Google hub)

Computers die praten voor u.



<https://www.youtube.com/watch?v=RAoRaz7mMIA>



Domotica en Internet of Things

- Hoeft niet met internet verbonden te zijn
- Hoeft niet gebruik te maken van TCP/IP protocol

Beter zou zijn:

Connected Devices.. of.. Smart Devices

Smart Home



TRENDING [Beste budget smartphone](#) [Beste laptop](#) [Beste smartwatch](#) [Beste iPhone](#) [Beste VPN](#)

<https://global.techradar.com/nl-nl/news>

TechRadar wordt ondersteund door zijn publiek. Wanneer je via links op onze site koopt, kunnen we een commissie verdienen. [Meer informatie](#)

TechRadar nieuws en features

Het laatste nieuws en achtergrond over technologie door TechRadar



Chrome krijgt eindelijk een broodnodige anti-hijacking functie

Google brengt het blokkeren van tab-hijacking naar de browser



Nog geen Windows 10 20H2 update gehad? Je SSD kan de oorzaak zijn



Moto E7 gelekte specificaties en beelden wijzen op naderende

TECHRADAR NEWSLETTER

Meld u aan voor het laatste nieuws, recensies, meningen, analyses en meer, plus de populairste technische deals!

Your Email Address

Nieuws en aanbiedingen van onze andere merken ontvangen?

Ja Nee

Mail van ons ontvangen namens onze vertrouwde partners of sponsors?

Ja Nee

SIGN ME UP

Geen spam, dat beloven we. Je kan altijd gemakkelijk uitschrijven en we delen je persoonlijke gegevens nooit zonder jouw toestemming.

MEEST POPULAIR



1 Zo installeer je de PS5 of PS5 Digital Edition

2 Apple Watch SE review

3 De beste Black Friday tv deals van 2020

4 Black Friday no gaming deals





Zoek een product



hosted by TRU



Smarthome

Smarthome » Overzicht

- Overzicht
- Reviews
- Nieuws
- Vraag & Aanbod
- Discussies & Vragen
- Meer v

Kies een categorie

Bediening	Verlichting	Bewakingscamera's	Alarmsystemen	Thermostaten	Basisstations	Sensoren	Schakelaars
Smarthome access...	Interfaces	Verbruiksmeters					

Onder de categorie smarthome vallen alle producten die een huis slimmer maken, bijvoorbeeld slimme thermostaten die het comfort te verbeteren en [verbruiksmeters](#) om het energieverbruik te monitoren en [energie te besparen](#).

In een smarthome kunnen veelgebruikte apparaten op afstand bieden worden of worden ze op de automatisch piloot geregeld, zodat het huis op de juiste momenten en op de gewenste temperatuur verwarmd wordt, de luchtkwaliteit optimaal is, [verlichting](#) automatisch aan- en uit gaat en de bewoners op elk moment via [bewakingscamera's](#) kunnen zien hoe hun huis er bij staat en wie er aanbelt aan de deur. [Sensoren](#) dienen als de zintuigen van een smarthome en sturen via een [basisstation](#) actoren aan of geven informatie door aan de gebruiker via een app of spraakgestuurde assistent zoals [Google Home](#) of [Amazon Echo](#).

Op Tweakers vind je het laatste nieuws over Smarthome, vergelijk je producten met elkaar en vind je de goedkoopste aanbieders van Smarthomeproducten. Wil je zelf een smarthome bouwen, lees dan ons artikel over de verschillende [smarthomestandaarden en -technieken](#). In het [Duurzame energie & Domotica forum](#) kun je vragen stellen over domotica en ervaringen uitwisselen met mensen die een smarthome hebben.

Laatste artikelen en video's

<https://tweakers.net/smarthome/>

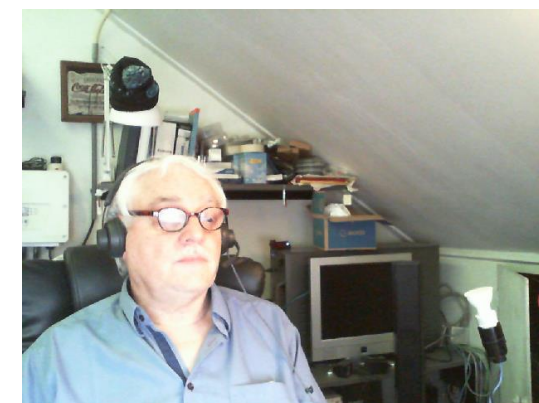

Karmaranglijst

Toon: Overall Afgelopen jaar

Connected devices hoe dan?

Binnenshuis (Domotica) via kabel, Wifi, Bluetooth
Buitenshuis via [4G-5G](#), [Sigfox](#), [LoraWAN](#), [NB-IoT](#)
[Industrial IoT \(M2M\)](#) via kabel. [MQTT](#)



Send a command to **control an output**



Read and **publish** data



Fake IoT (domme afstandbediening via internet)

Garagedeuropener-app
Thermostaat-app
Etc.





https://www.qualcomm.com/invention/5g/what-is-5g

Everything you need to know about 5G.

Here is where you find 5G technology explained—how 5G works, why 5G is important and how it’s changing the way the world connects and communicates. At Qualcomm, we invented the foundational breakthroughs that make 5G possible.

5G FAQs

- What is 5G?
- How's 5G Different?
- 5G Economic Impact?
- Where's 5G being used?
- How fast is 5G?
- Is 5G available now?
- Do I need a 5G phone?

Q: What is 5G?

A: 5G is the 5th generation mobile network. It is a new global wireless standard after 1G, 2G, 3G, and 4G networks. 5G enables a new kind of network that is designed to connect virtually everyone and everything together including machines, objects, and devices.

5G wireless technology is meant to deliver higher multi-Gbps peak data speeds, **ultra low latency**, more reliability, massive network capacity, increased availability, and a more uniform user experience to more users. Higher performance and improved efficiency empower new user experiences and connects new industries.

[OnQ Blog: 5G in 101 Seconds](#) > [More 5G Resources](#) >



Expand all + Collapse all -

Q: Who invented 5G?



Q: What underlying technologies make up 5G?



SIGFOX

The world's leading service provider for Internet of Things (IoT). One global 4G network to connect your physical world with the digital universe and power industry transformation.

#smalldatabigresults

DISCOVER

SIGFOX, A 4G NETWORK CONNECTING YOUR PHYSICAL WORLD

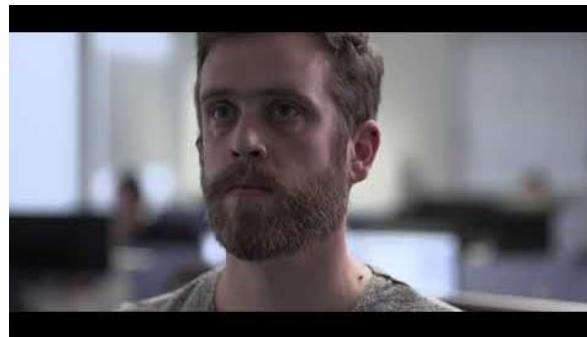

GLOBAL COVERAGE MAP
Enjoy the world's largest IoT Network.

DISCOVER

- 1.3 billion people covered
- 72 countries covered
- 5.7 million km² covered

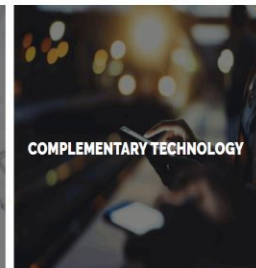
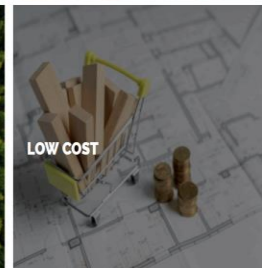



This documentation page applies to the legacy Things Network Stack V2. Documentation for The Things Stack V3 is available [here](#)

LoRaWAN

Fundamental

LoRaWAN Architecture

Regional Parameters

Limitations

Specifications

Classes

Addressing & Activation

Modulation & Data Rate

Adaptive Data Rate

Duty Cycle

Security

Additional Information

Frequency Plans

Frequency Plans by Country

NetID and DevAddr Prefix Assignments

Get started with LoRaWAN

LoRaWAN

This section covers everything you need to know to get started with LoRaWAN and improve your knowledge of the technology.



Internet of Things <https://www.gsma.com/iot/narrow-band-internet-of-things-nb-iot/>

Home > Mobile IoT (LPWA)

Mobile IoT (LPWA)

LTE-M

NB-LoT

Commercial Launches

Deployment Map

IoT Labs Map

Evolution Tracker

GSMA IoT Marketing Group

[Back to Home](#)



Upcoming Events

BUILDING THE UAM
ECOSYSTEM

**Amsterdam Drone Week
2020 Hybrid**

Start: 1 Dec 2020
End: 3 Dec 2020

[Find Out More](#)

Latest Resources

**On-Demand IoT WebTalk:
Delivering 5G Quality of
Service (QoS) for Connected
and Automated Driving**

In this IoT WebTalk, industry experts from T-Systems and Ottopia discuss the



NarrowBand-Internet of Things (NB-LoT) is a standards-based low power wide area (LPWA) technology developed to enable a wide range of new IoT devices and services. NB-LoT significantly improves the power consumption of user devices, system capacity and spectrum efficiency, especially in deep coverage. Battery life of more than 10 years can be supported for a wide range of use cases.

New physical layer signals and channels are designed to meet the demanding requirement of extended coverage - rural and deep indoors - and ultra-low device complexity. Initial cost of the NB-LoT modules is expected to be comparable to GSM/GPRS. The underlying technology however much simpler than today's GSM/GPRS and its cost is expected to decrease rapidly as demand increases.

Supported by all major mobile equipment, chipset and module manufacturers, NB-LoT can co-exist with 2G, 3G, and 4G mobile networks. It also benefits from all the security and privacy features of mobile networks, such as support for user identity confidentiality, entity authentication, confidentiality, data integrity, and mobile equipment identification. The first NB-LoT commercial launches have been completed and global roll out is expected for 2017/18.

[Download the NB-LoT Logo](#)



https://www.ixon.cloud/all-in-one-industrial-iiot-solution

All-in-one Industrial IIoT solution

A complete, affordable and cost-saving Industrial IIoT-solution for machine builders, system integrators and engineers: IXON Cloud.

Reduce your on-site visits now with secure remote VPN access and start **creating value** with PLC data logging, dashboards and alarms. #hasslefreeiiot with just one single solution. We support all major PLCs, HMIs and robot brands.

There are many solutions on the market that offer remote access, data logging or IIoT platform components. That makes it really **difficult to choose the right solution**. But what exactly are the differences and which solution is the best Industrial IIoT platform for your short and long term operation? Before you decide, take a look at IXON's IIoT solution, where **all features come together** in a secure, scalable and easy-to-use platform.

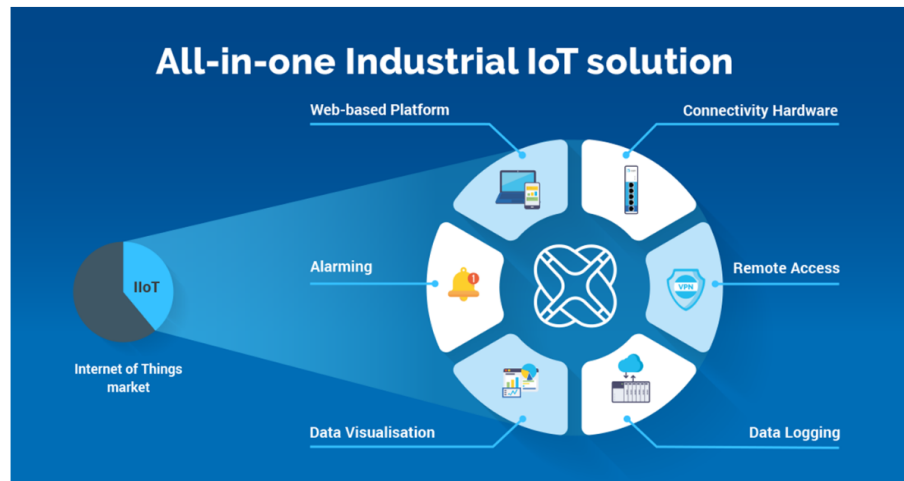

IIoT vs IoT

The Internet of Things (IoT) is widely used and is embedded in our daily lives with gadgets such as wearables, smart ovens or other consumer products. **Industrial IIoT (IIoT)** refers to a subcategory of IoT that focuses specifically on **industrial applications** such as industrial manufacturing, packaging, (new) energy or robotics.



https://en.wikipedia.org/wiki/Machine_to_machine



Not logged in [Talk](#) [Contributions](#) [Create account](#) [Log in](#)

Article [Talk](#)

[Read](#) [Edit](#) [View history](#)

Machine to machine

From Wikipedia, the free encyclopedia

Machine to machine (M2M) is direct communication between devices using any [communications channel](#), including [wired](#) and [wireless](#).^{[1][2]} Machine to machine communication can include industrial instrumentation, enabling a sensor or meter to communicate the information it records (such as temperature, inventory level, etc.) to application [software](#) that can use it (for example, adjusting an industrial process based on temperature or placing orders to replenish inventory).^[3] Such communication was originally accomplished by having a remote network of machines relay information back to a central hub for analysis, which would then be rerouted into a system like a [personal computer](#).^[4]

More recent machine to machine communication has changed into a system of networks that transmits data to personal appliances. The expansion of [IP](#) networks around the world has made machine to machine communication quicker and easier while using less power.^[5] These networks also allow new business opportunities for consumers and suppliers.^[6]

Contents [\[hide\]](#)

- History
 - In the 2000s
 - In the 2010s
- Applications
- Networks in prognostics and health management
- Open initiatives
- See also
- References
- Further reading

History [\[edit\]](#)

Wired communication machines have been using [signaling](#) to exchange information since the early 20th century. Machine to machine has taken more sophisticated forms since the advent of computer networking automation^[7] and predates [cellular communication](#). It has been utilized in applications such as [telemetry](#), [industrial automation](#), and [SCADA](#).

Machine to machine devices that combined telephony and computing were first conceptualized by [Theodore Paraskevavos](#) while working on his [Caller ID](#) system in 1968, later patented in the U.S. in 1973. This system, similar but distinct from the [panel call indicator](#) of the 1920s and [automatic number identification](#) of the 1940s, which communicated telephone numbers to machines, was the predecessor to what is now [caller ID](#), which communicates numbers to people.

- [Main page](#)
- [Contents](#)
- [Current events](#)
- [Random article](#)
- [About Wikipedia](#)
- [Contact us](#)
- [Donate](#)
- [Contribute](#)
- [Help](#)
- [Learn to edit](#)
- [Community portal](#)
- [Recent changes](#)
- [Upload file](#)
- [Tools](#)
- [What links here](#)
- [Related changes](#)
- [Special pages](#)
- [Permanent link](#)
- [Page information](#)
- [Cite this page](#)
- [Wikidata item](#)
- [Print/export](#)
- [Download as PDF](#)
- [Printable version](#)



Getting started

MQTT Specification

Software

Use Cases

FAQ

MQTT: The Standard for IoT Messaging

MQTT is an OASIS standard messaging protocol for the Internet of Things (IoT). It is designed as an extremely lightweight publish/subscribe messaging transport that is ideal for connecting remote devices with a small code footprint and minimal network bandwidth. MQTT today is used in a wide variety of industries, such as automotive, manufacturing, telecommunications, oil and gas, etc.

Getting started with MQTT



Why MQTT?

Lightweight and Efficient

MQTT clients are very small, require minimal resources so can be used on small microcontrollers. MQTT message headers are small to optimize network bandwidth.

Reliable Message Delivery

Reliability of message delivery is important for many IoT use cases. This is why MQTT has 3 defined quality of service levels: 0 - at most once, 1- at least once, 2 - exactly once

Bi-directional Communications

MQTT allows for messaging between device to cloud and cloud to device. This makes for easy broadcasting messages to groups of things.

Support for Unreliable Networks

Many IoT devices connect over unreliable cellular networks. MQTT's support for persistent sessions reduces the time to reconnect the client with the broker.

Scale to Millions of Things

MQTT can scale to connect with millions of IoT devices.

Security Enabled

MQTT makes it easy to encrypt messages using TLS and authenticate clients using modern authentication protocols, such as OAuth.

MQTT Publish / Subscribe Architecture

Domotica-IOT toepassingen.

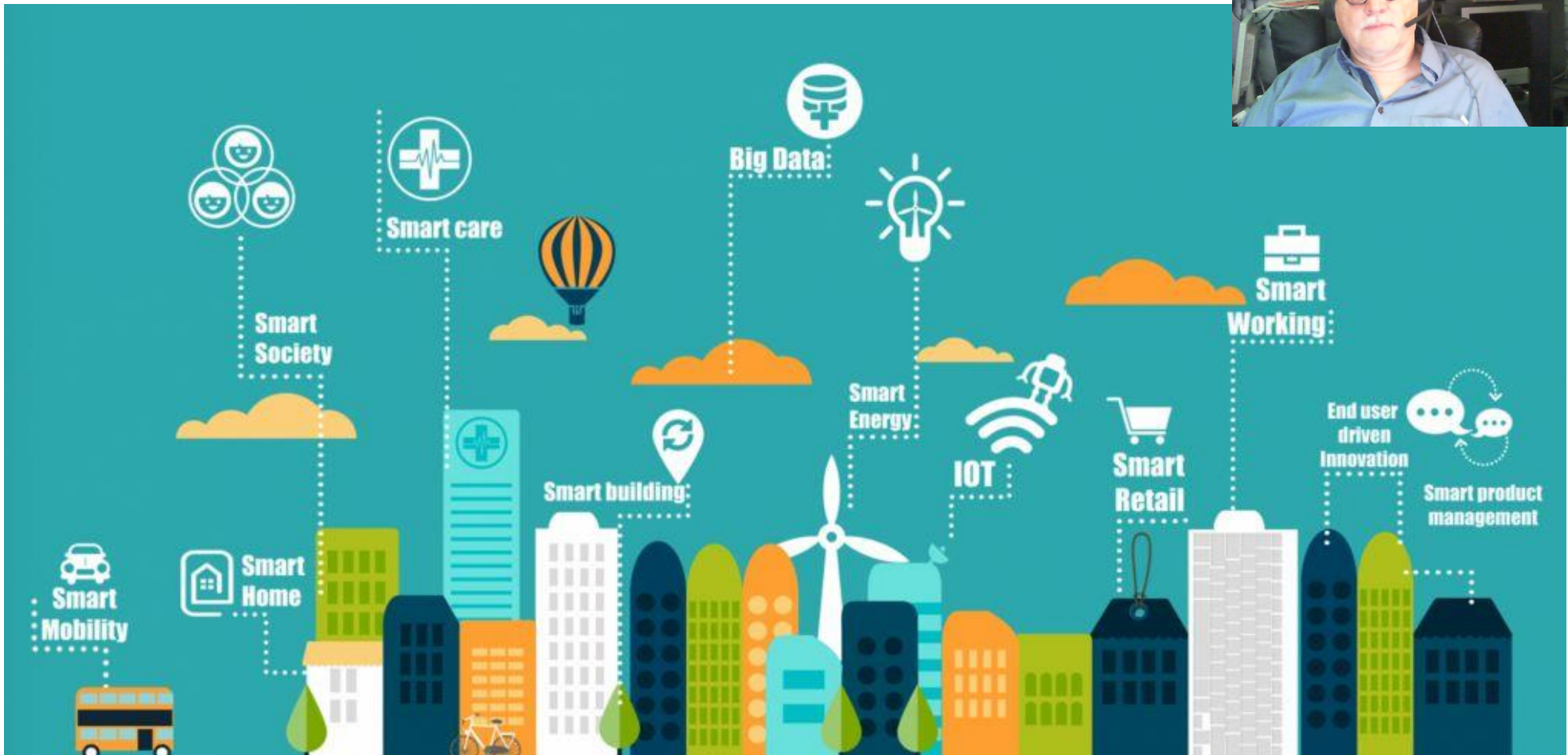

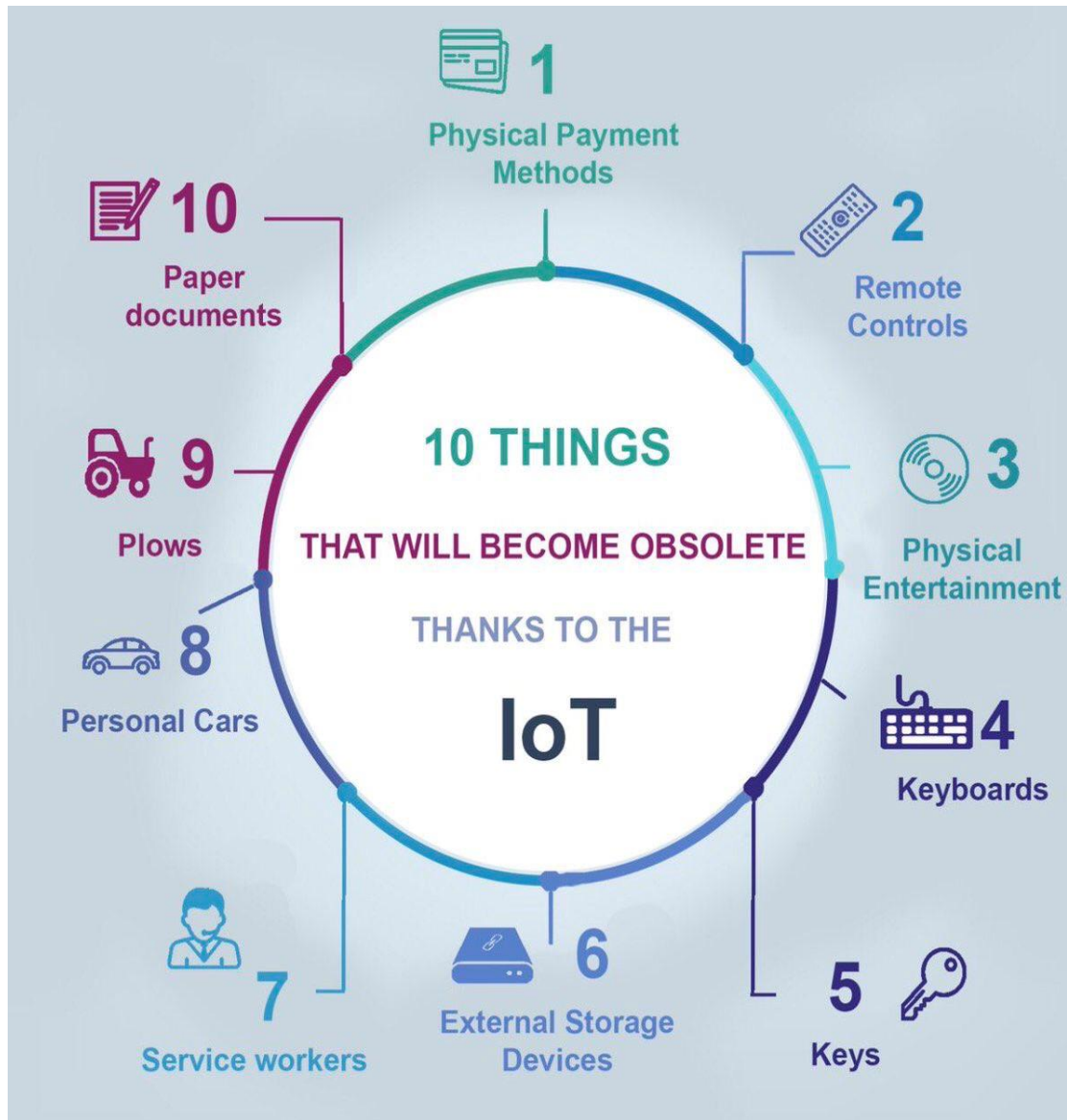

- Betalen met smartphone
- Afstandsbediening via spraak
- Muziek streamen geen cd's meer
- Spraak typen
- Geen sleutel dmv gezichtsherkenning
- Cloud opslag
- Geen lokaal beheer meer
- Geen eigen auto
- Robots
- Geen papier meer



Kruispunt van de toekomst?



<https://www.youtube.com/watch?v=Johmxw3cs>



Het hoeft allemaal niet zo moeilijk...

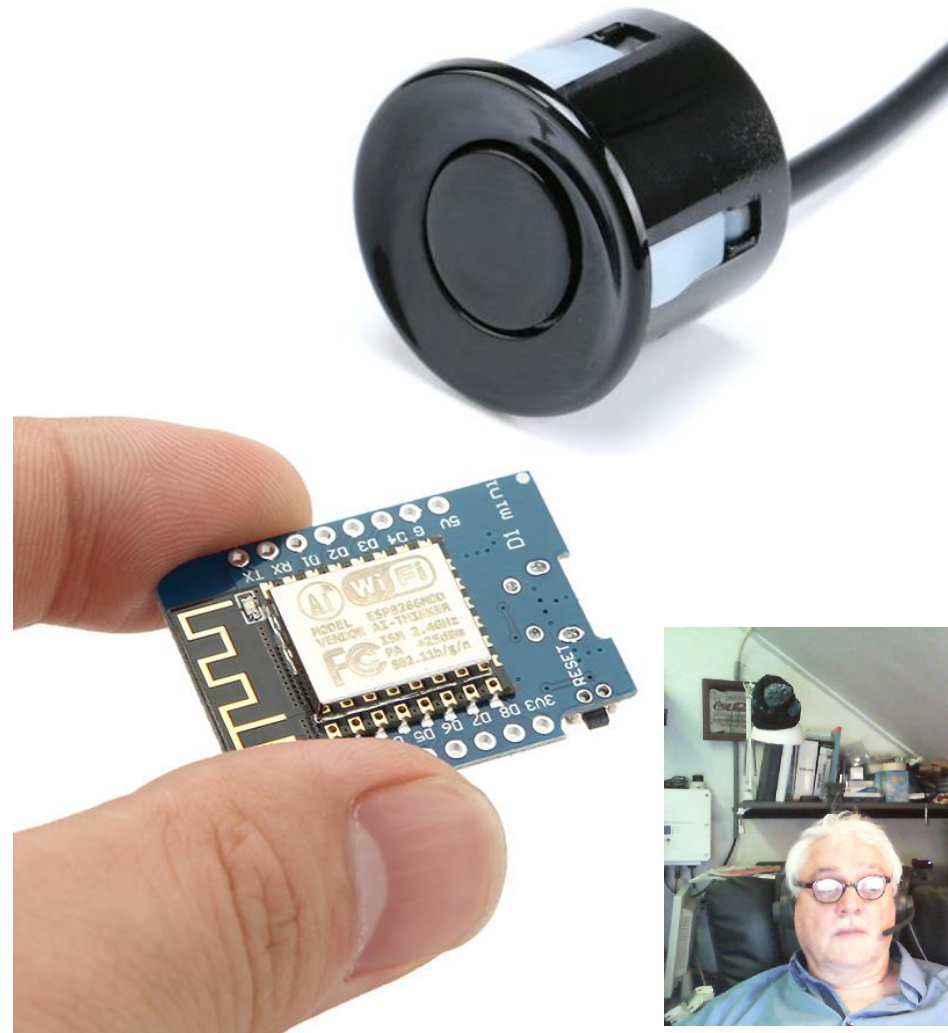

ESP8266



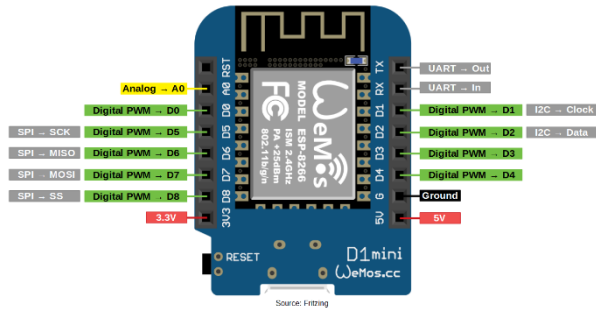

Home is where the ~~hart~~



is



Domotica systemen.

- ❗ APP op smartphone voor de gewone gebruiker geschikt
- ❗ Een eigen stelsysteem van een aanbieder.
- ❗ Zelfbouw (raspberry-pi of Arduino)



KPN SmartLife

Stopt vanaf 1 januari 2021

Home > Thuis > KPN SmartLife

KPN SmartLife

Steeds meer klanten gebruiken slimme apparaten in huis. De ontwikkelingen op dit gebied gaan wereldwijd in een hoog tempo. Vanwege deze nieuwe ontwikkelingen is besloten om onze aanpak aan te passen en ons te richten op samenwerkingen met geselecteerde partners. **Daarom stoppen we helaas met KPN SmartLife.** We beëindigen alle KPN SmartLife abonnementen en de betalingen op 1 januari 2021.

[Over KPN SmartLife stopt](#)



Veelgestelde vragen

Waarom stopt KPN SmartLife? 

Waar vind ik meer informatie over dit onderwerp? 

Tot wanneer kan ik mijn KPN SmartLife apparaten gebruiken? 

Ben je al klant of heb je een vraag?

Kijk dan gerust rond op de servicepagina's als je al klant bent of als je meer wilt weten over het gebruik van KPN SmartLife.

[Service en contact](#)



[Home](#) > [Other Smart Home](#)

Smart Life App - a Comprehensive Guide - Everything You Need to Know

In this review guide we cover what Smart life can do. Smart Life features, device compatibility, IFTTT, how to set up and more



IFTTT

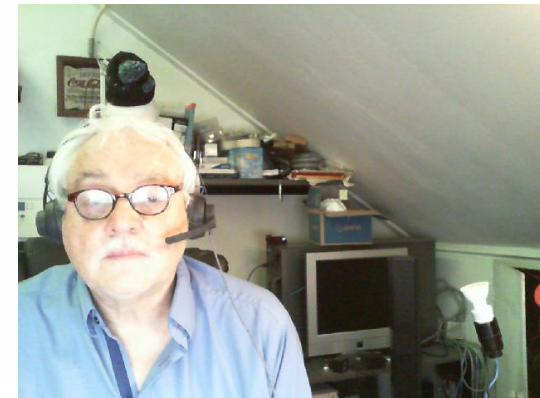



NIEUWS BESTE DEALS ▾ PLATFORM ▾ VERLICHTING & TOEGANG ▾ KLIMAAT ▾ MEDIA ▾

Home > Smart Home Kennisbank > Wat is een Domotica Systeem

Smart Home Kennisbank

Wat is een Domotica Systeem

04/01/2020



Homey, Google Home, Amazon Alexa of Apple Homekit, het zijn allemaal termen die vaak voorbijkomen op het internet en Social Media. Dit zijn [Smart Hubs](#), maar worden ook wel eens Smart Home Systemen of Domotica systemen genoemd. Maar wat is een Domotica Systeem eigenlijk? Wat zijn de functies van een Domotica Systeem en wat is het beste Domotica Systeem? Deze en meer vragen worden beantwoordt in dit artikel.





Domoticz Control at your finger tips.



The screenshot displays several status cards for different devices in a Domoticz installation:

- Front**: Status: Group On, Last Seen: 2012-11-29 20:37:10, Type: Lighting 2, AC
- Doorbell Side**: Status: Group On, Last Seen: 2012-12-01 11:39:27, Type: Lighting 2, AC
- Outside Light**: Status: Off, Last Seen: 2012-12-02 01:09:01, Type: Lighting 2, AC
- Remote Location Humidity**: Status: Humidity: 81 % (Wet), Last Seen: 2012-12-02 10:39:53, Type: Humidity, LaCrosse TX3
- Remote Location Temp**: Status: 5.3° C, Last Seen: 2012-12-02 10:39:53, Type: Temp, LaCrosse TX3
- Temp. Livingroom**: Status: 23.5° C, Humidity: 34 % (Dry), Last Seen: 2012-12-02 10:39:43, Type: Temp + Humidity, Cresta, TFA TS34C
- Wind Meter**: Status: 8.4° C, Chill: 8.1° C, 202 SSW, Speed: 1.2 ms, Gust: 1.7 ms, Last Seen: 2012-12-02 10:39:52, Type: Wind, TFA



Domoticz is a Home Automation System that lets you monitor and configure various devices like: Lights, Switches, various sensors/meters like Temperature, Rain, Wind, UV, Electra, Gas, Water and much more. Notifications/Alerts can be sent to any mobile device.

Node-RED

Low-code programming for event-driven applications

Latest version: v1.2.3 (npm)



Node-RED is a programming tool for wiring together hardware devices, APIs and online services in new and interesting ways.

It provides a browser-based editor that makes it easy to wire together flows using the wide range of nodes in the palette that can be deployed to its runtime in a single-click.

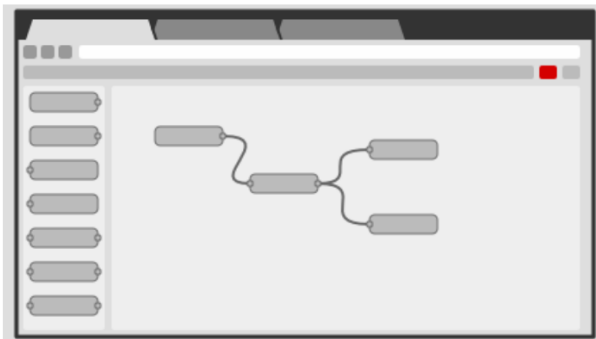
[Features](#)[Get Started](#)[Community](#)

Browser-based flow editing

Node-RED provides a browser-based flow editor that makes it easy to wire together flows using the wide range of nodes in the palette. Flows can be then deployed to the runtime in a single-click.

JavaScript functions can be created within the editor using a rich text editor.

A built-in library allows you to save useful functions, templates or flows for re-use.

<https://nodered.org/>

Wat kost een domotica systeem om mijn huis slim te maken.

❗ Hoe slim bent u?

❗ Action, Aliexpress, Lokale Domotica shops.

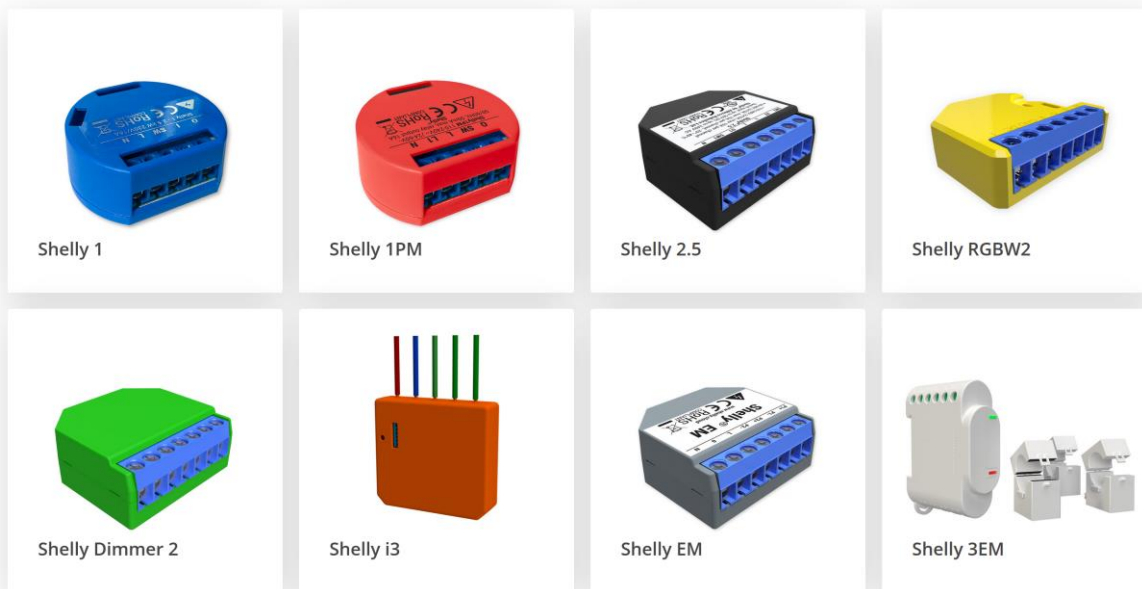

Maatregelen om samen veilig te winkelen



LSC Smart Connect
**Be smart! Maak het jezelf
makkelijk met een slim
huis**



795

LSC Smart Connect
afstandsbediening
20 meter bereik



795

LSC Smart Connect
bewegingsmelder
12 meter bereik



995

LSC Smart Connect
bewegingsmelder
5 meter bereik

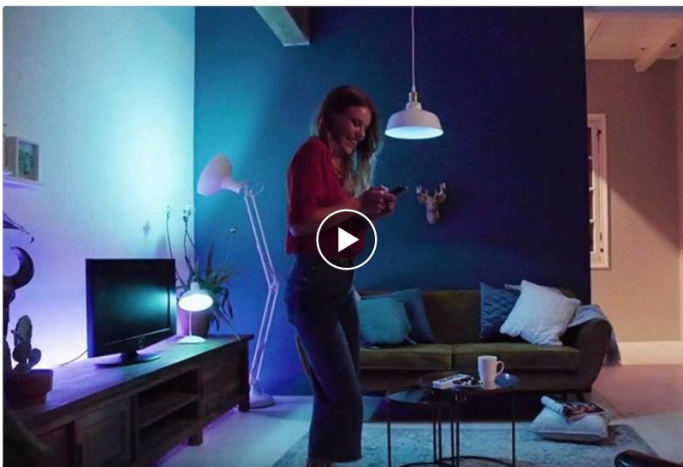

2495

LSC Smart Connect indoor IP-
camera
1080p HD



1995

LSC Smart Connect ledstrip
5 meter



Gerelateerde Rubrieken

- Consumentenelektronica
- Woninginrichting
- Licht & verlichting
- Elektronische Componenten & Benodigheden

Bekijk Meer

Merken

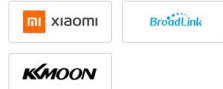

AliExpress Mobile App
Zoek Anywhere, Anytime!



Scan of klik om te downloaden

Alle Rubrieken > "sonof" (2,878 Resultaten)

Bedoelt u 'sonoff'?

Prijs: min - max schip uit **!!! SALE** Select Coupon Gratis Verzending Gratis retourneren ★★★★★ of meer

Sorteren op: **Beste overeenkomst** Bestellingen Nieuwste Prijs

Bekijk:

SALE Neo Coolcam Smart Plug ...
€ 7,13 - 30,73
 €15,84 - 68,29 **55% korting**
 Gratis Verzending
 Gratis retourneren
 ★ 4.8 822 verkocht
 Coolcam Official Store

SALE Google Home Compatibel ...
€ 10,34 - 12,77
 €14,77 - 18,25 **30% korting**
 Gratis Verzending
 ★ 4.9 65 verkocht
 Mumubiz Wi-Fi Store

SALE 16A Mini Smart Wifi Diy S...
€ 6,63
 €13,26 **50% korting**
 Gratis Verzending
 ★ 4.9 2016 verkocht
 GIRIER Official Store

SALE Ewelink Smart Usb 5V Diy ...
€ 4,87 - 6,15
 €8,25 - 10,42 **41% korting**
 ★ 4.9 271 verkocht
 Mumubiz Wi-Fi Store

SALE Ewelink 16A Smart Wifi Stroomond...
€ 34,05 - 41,59
 €54,92 - 67,07 **38% korting**
 Gratis Verzending
 ★ 5.0 26 verkocht
 TuyaSmart Store

SALE Tuya/ Ewelink Smart Wifi S...
€ 10,13 - 10,21
 €21,54 - 21,71 **53% korting**
 Gratis Verzending

SALE Ski Bril, winter Sneeuw Sp...
€ 10,42 - 16,39
 €17,38 - 27,32 **40% korting**
 Gratis Verzending
 Gratis retourneren

SALE 2020 Nieuwe Wifi Rf Ir Uni...
€ 25,69
 €37,23 **31% korting**
 Gratis Verzending

SALE Apple Homekit Garage Jal...
€ 41,29
 €62,57 **34% korting**

SALE Apple Home...
€ 34,03
 €38,24 **11% korting**

https://nl.aliexpress.com/af/sonof.html?d=y&origin=n&SearchText=sonof
initiative_id=SB_20200901002212





RASPBERRY PI 4B 8GB

SHOP NU >



RASPBERRY PI 3B+ IN VOORRAAD

SHOP NU >



RASPBERRY PI SETJES

SHOP NU >



EDUCATIEVE ELEKTRONICA SETJES

SHOP NU >



NVIDIA JETSON B01

SHOP NU >

Populaire producten

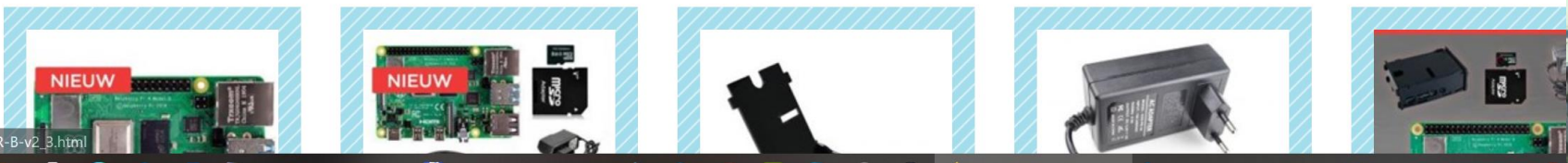

Besteld op ma-vr voor 17:00u is zelfde dag verzonden

Gratis verzending vanaf € 75 binnen Nederland

Wereldwijde verzending Naar elke bestemming met UPS

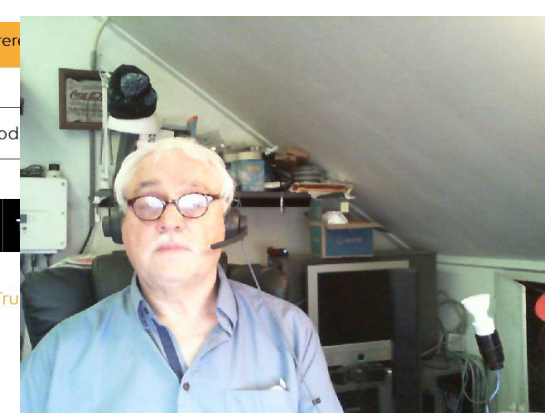

Aanbevolen

<https://www.kiwi-electronics.nl/>



Raspberry Pi 4 Model B Basis Bundel - Zwart/Grijs - 4GB

€ 94,95

In winkelwagen



Micro:Maqueen + Mechanical Part set (micro:bit)

€ 69,95

In winkelwagen



Grove Beginner Kit for Arduino - All-in-one Arduino Compatible Board with 10 Sensors and 12 Projects

€ 24,95

In winkelwagen



Snap Circuits MyHome - MYH7





€ 59,95

In winkelwagen

Blog

-  **Raspberry Pi 400: de desktop-pc van €80,-**
05-11-2020 0
-  **Halloween Projects**
06-10-2020 0
-  **Een jaar na de brand**
16-07-2020 4
-  **Aanvullende tutorials voor de :MOVE motor voor micro:bit**
10-07-2020 0
-  **Logistiek medewerker gezocht!**
07-07-2020 1

Aanbiedingen

-  **Slide Beam 2424-152 - Bl...**
€ 7,35 € 5,51
-  **Worm Geared Motor Bra...**
€ 1,50 € 1,13
-  **Inkortbaar koppelstuk 0...**
€ 5,75 € 4,31
-  **mCore Case**
€ 3,45 € 2,59
-  **LED RGB Strip-Addressa...**
€ 12,50 € 9,38

Nieuwe Producten

thuiswinkel waarborg **Gratis training bij aankoop** Advies nodig? Bel 010-3335150 [NEEM CONTACT MET ONS OP](#) [INLOGGEN](#) [ACCOUNT AANMAKEN](#)

DeDomotica Store.nl
SMART HOME EXPERIENCE CENTER

Zoeken naar... [KLANTENSERVICE](#)

[HOME](#) [PHILIPS HUE](#) [WIZ](#) [DOMOTICA SYSTEMEN](#) [VERLICHTING](#) [AUDIO](#) [BEVEILIGING](#) [LAADSTATIONS](#) [MERKEN](#) [MEER](#)

- Maak kennis met Philips Hue**
- Hue Startersets
 - Hue Lampen
 - Hue LightStrips
 - Hue Binnen
 - Hue Buiten
 - Hue Inbouwspots
 - Hue Outdoor
 - Hue Bediening

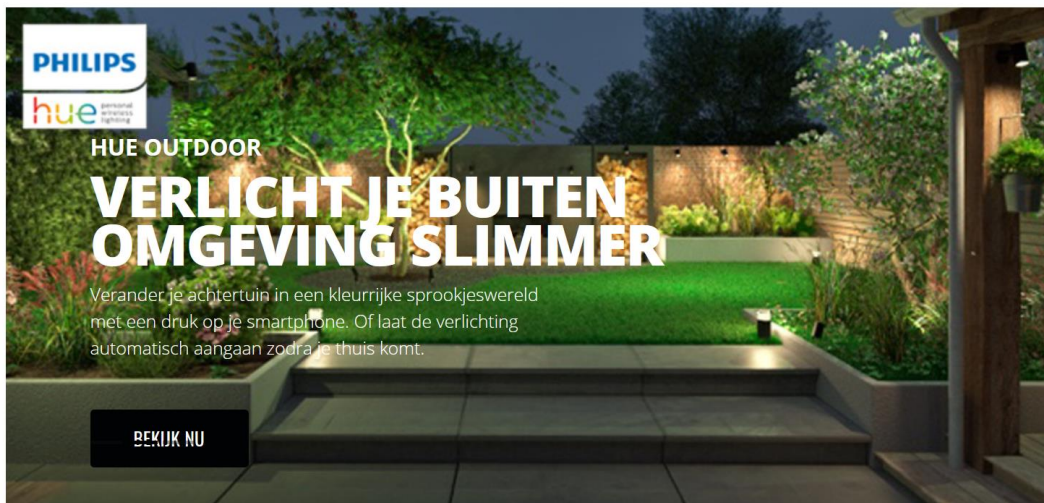

KLANTENSERVICE
Bel 010 - 3335150

GRATIS VERZENDING
Bij bestellingen vanaf 50 euro

SHOWROOM
Bezoek ons in Capelle aan den IJssel



Zelf met Domotica-IoT aan de slag?

Koop het boekje “Zelf een IoT toepassing maken” van Rudi Niemeijer

<https://www.bol.com/nl/c/boeken-rudi-niemeijer/15517343/N/8299/>

Koop voor een paar euro een

NodeMCU V3 ESP8266

<https://www.hobbyelectronica.nl/product/nodemcu-v3-4mb-flash-esp8266-12e/>

En een PIR sensor

<https://www.hobbyelectronica.nl/product/hc-sr501-pir-bewegingssensor-infrarood/>

Nog een paar draadjes en een USB-kabel..
(eventueel op Youtube NodeMCU of ESP8266 zoeken)

VEEL plezier!

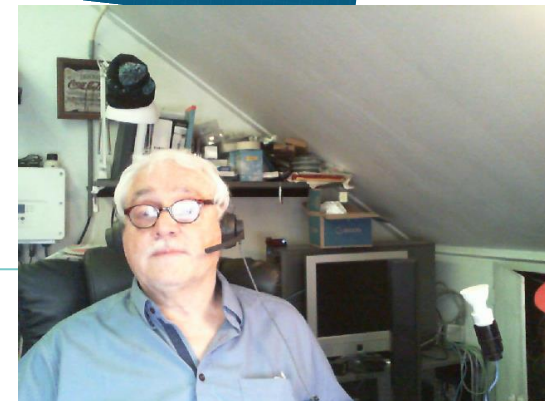

Privacy

Er is in de laatste 5 jaar meer data opgeslagen dan in de 2000 jaar ervoor!

Waarvoor wordt die data gebruikt?
Wie heeft toegang?
Etc.

Regelgeving wordt aangescherpt maar...
ook de Nederlandsche Staat is hierin
niet altijd netjes!



Wie is eigenaar van de/uw data?

Internet: *“If your not paying for it... YOU’R the product!”*

Facebook

Google

Etc.

In mijn ogenschijnlijk waardeloze data zit misschien wel een schat aan informatie..

Wie verzilverd dit?

Wie vraagt mij toestemming om dat te doen?

Krijg ik mijn deel?

De nieuwe Renaissance



De nieuwe Renaissance

- ❗ Nederland zal de komende decennia transformeren naar een nieuwe samenleving waarin de machtsverhoudingen zoals we die nu kennen radicaal zijn omgegooid. Dit is geen idealistisch vergezicht, maar de onontkoombare uitkomst van de kantelperiode waarin Nederland zich nu bevindt.
- ❗ De Tech bedrijven hebben nu de macht naar zich toegetrokken.
 - Google
 - Microsoft
 - Amazon
 - China
- ❗ Totale controle over de mens.
 - Smartphone
 - Onderhuids chip
 - Burgerschap punten systeem
- ❗ Wat kan u er tegen doen!

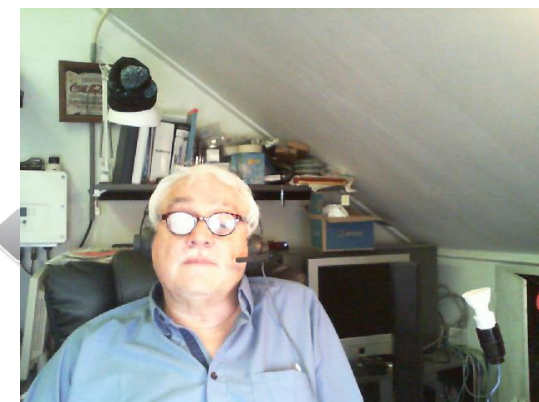



Beveiliging

Vroeger hadden we een internetbrowser en een mail-programma die een mogelijk beveiligingsrisico opleverden...

Tegenwoordig is het aantal apparaten dat we met internet verbinden veel groter... en daarmee (exponentieel) ook het risico!

Zolang er mensen/organisaties zijn die van anderen willen/kunnen profiteren zal misbruik blijven bestaan.. maar.. laten we het niet opblazen...



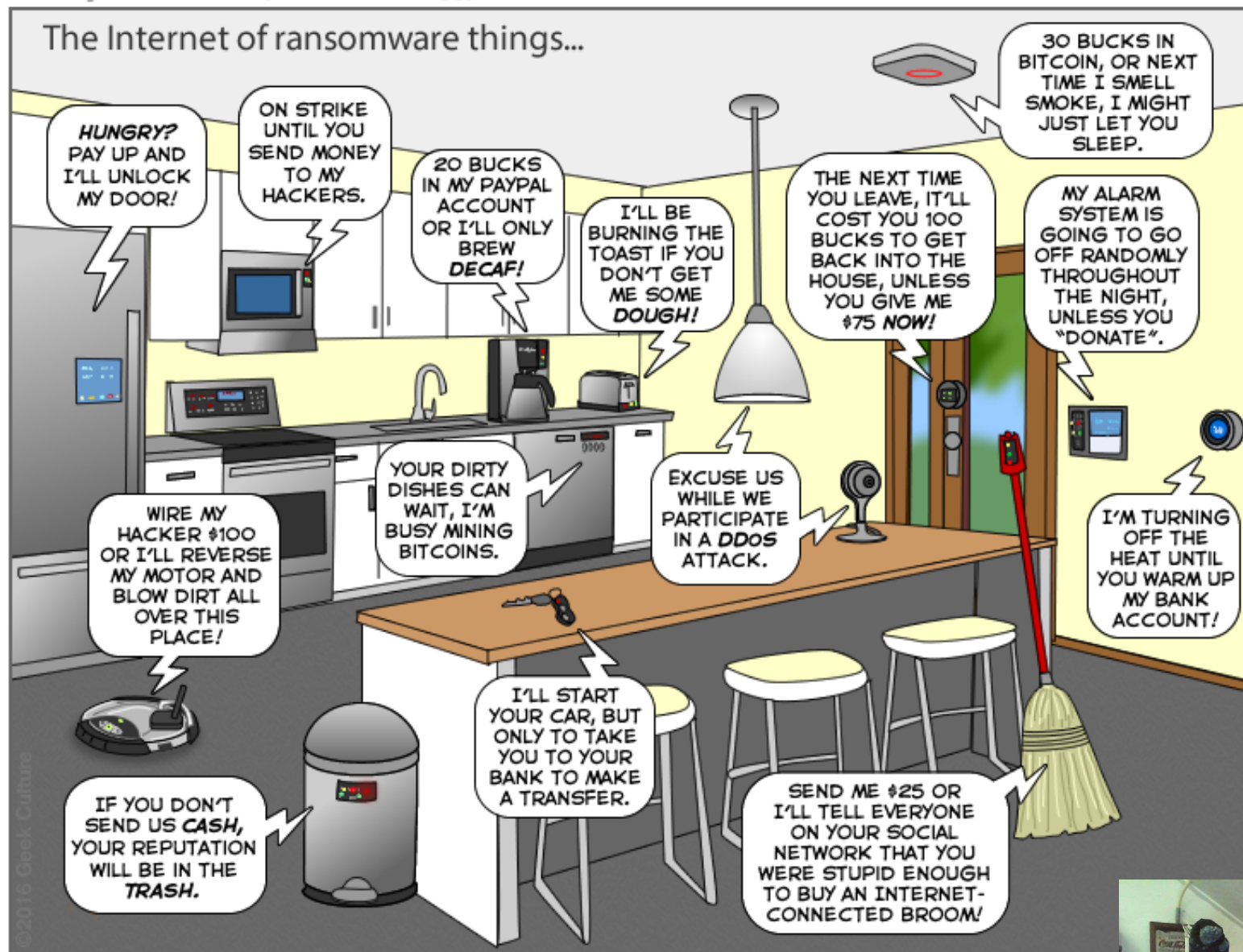

You can help us keep the comics coming by becoming a patron!
www.patreon/joyoftech

joyof



Internetbeveiliging is het simpel?

- ❗ Laat alleen communicatie toe die u vertrouwd!
- ❗ Versleutel uw communicatie met anderen en de buitenwereld.



Smart Citizen Platform Covid-19

Data, kennis en mensen verbinden. Het doel van het platform is om als een knooppunt te fungeren voor sensoren, tools en mensen om een positieve bijdrage te leveren aan de leefbaarheid van een stad ten behoeve van zijn inwoners.

De Tech bedrijven hebben de nieuwe melkoe ontdekt.



<https://skopjepulse.mk/>

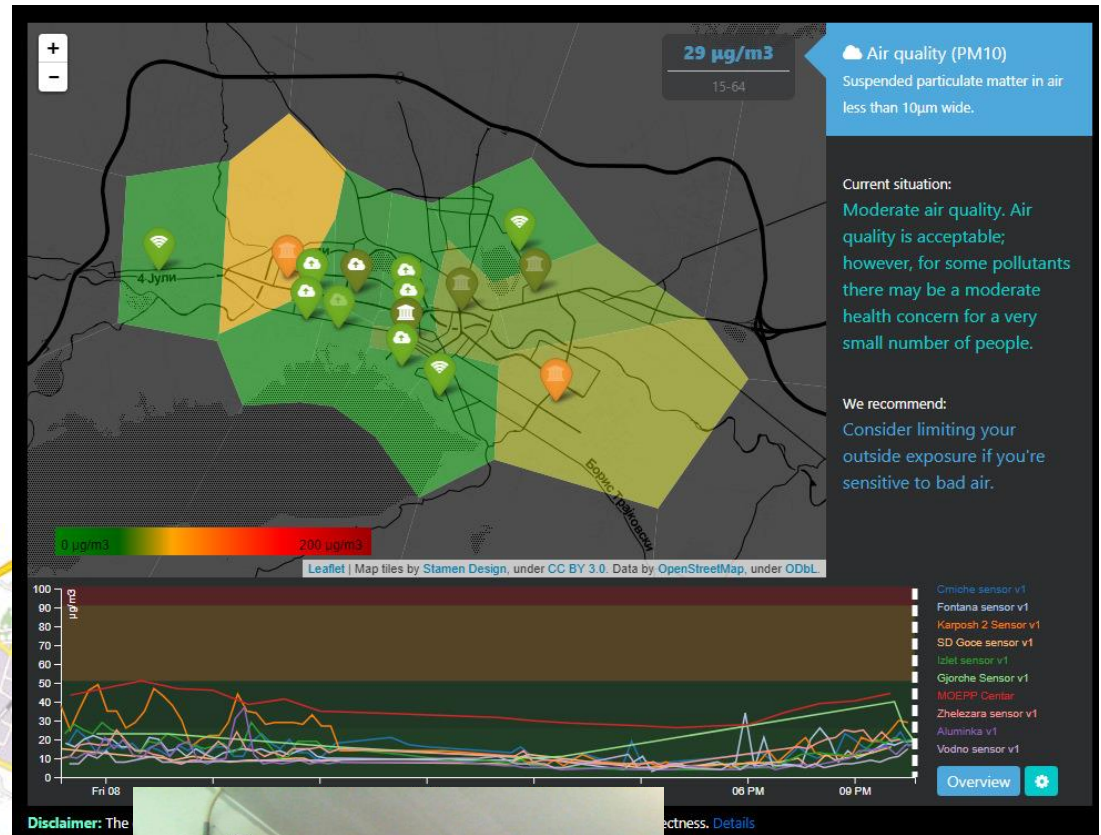
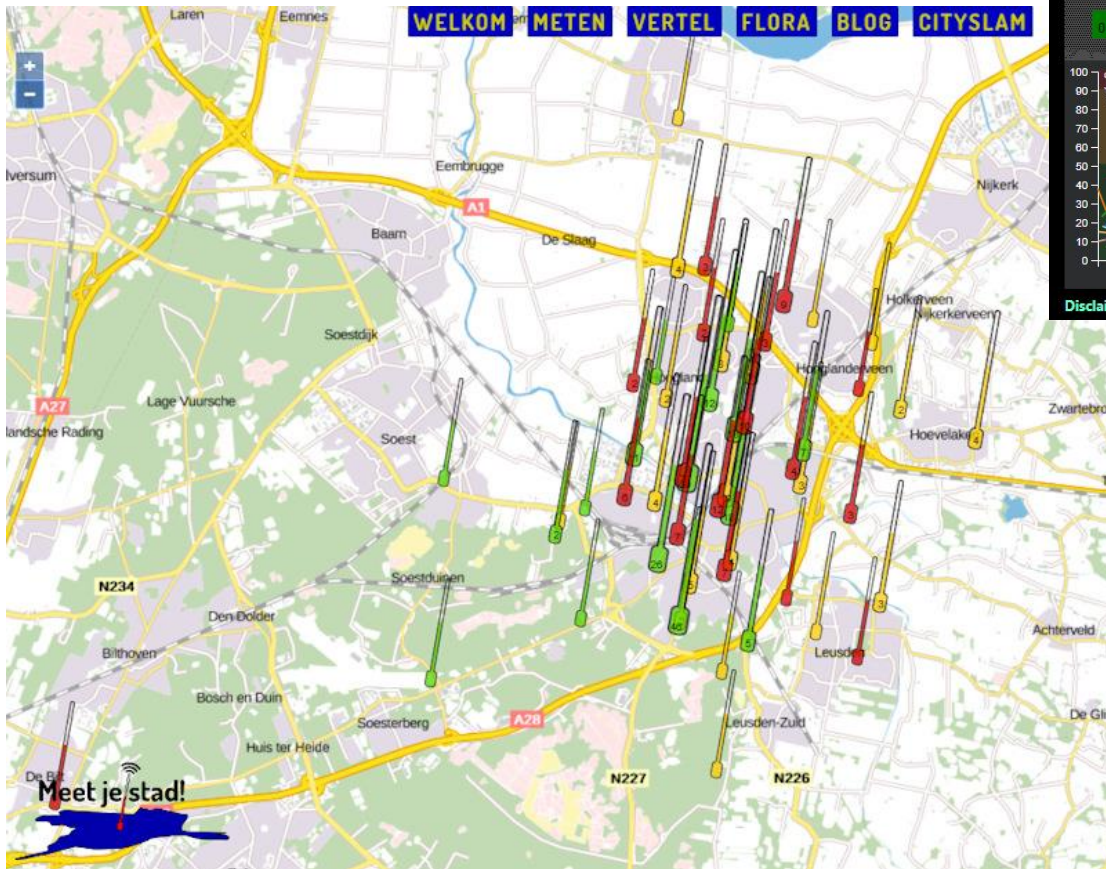

<http://meetjestad.net/>
<https://apeldoornindata.nl>

***We leven niet in een tijdperk van veranderingen,
maar in een verandering van tijdperk*** (Prof. Jan Rotmans)

ALLES gaat op z'n kop!

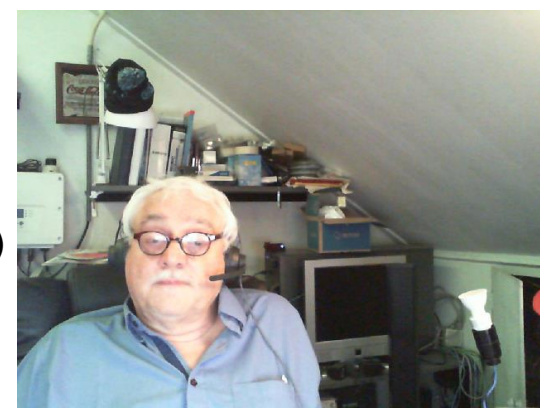

**Het klinkt als een cliché maar:
Er zijn ongekennde mogelijkheden voor iedereen..**

Cloudservices

voor opslag maar ook voor processing en analytics
(ook u kunt gratis gebruik maken van IBM Watson de supercomputer)

Kunstmatige Intelligentie

er zijn complete toolboxes waarmee
u zelf een chatbot kunt maken

Computervision

voor een paar tientjes met een Raspberry Pi
een beeldherkenningssysteem
opzetten met OpenCV?.. het kan!

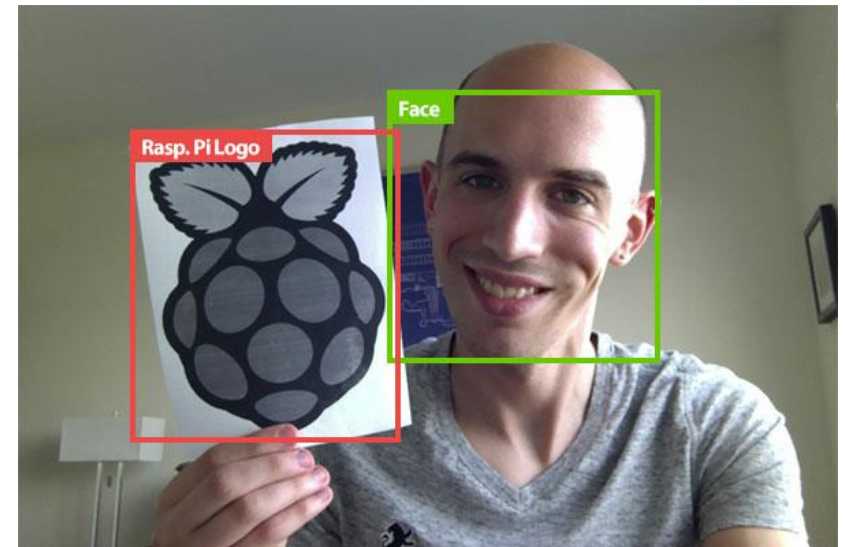

E-Sports

Wie had er 15 jaar geleden gedacht dat het spelen van computer-spelletjes een olympische sport gaat worden?
dat voetbalclubs jonge gamers een **GOED** betaalde baan zouden bieden?



Cryptocurrencies

Wie had gedacht dat we met “bitjes” kunnen betalen?
en dat we zelf bitcoins kunnen minen?



Ethereum de wereldcomputer...

Blockchain



HCC doet al 40 jaar aan communitybuilding..

Wat is “the next step” ?

(internet heeft de wereld veranderd – ook voor de HCC!)

- Nieuwe Interesse Groepen.

Onder andere:

- Android
- Domotica-iot
- Online communities faciliteren <https://wij.hcc.nl/>
- ??!! Skype video bijeenkomsten.
- Discord <https://discord.gg/7KtMHFt>

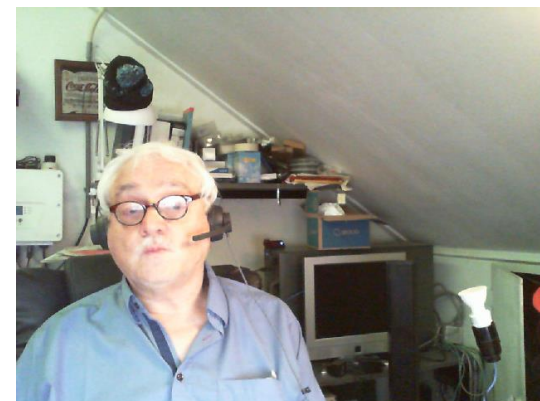

“Don’t tell me the sky is the limit...
when there are footsteps on the moon”
Paul Brandt

g.zwaagstra@hccnet.nl

